



**高速光耦**  
**High Speed Photo**  
**Coupler**

**ATH11LX**

**Product Data Sheet**

**AOTE DCC**  
**RELEASE**

**台湾奥特半导体科技有限公司**

TAIWAN AOTE SEMICONDUCTOR TECHNOLOGY CO.,LTD

[www.aotesemi.com](http://www.aotesemi.com)

## 概述 Description

ATH11LX 系列器件具备 GaAs 红外发射二极管，该二极管光学耦合到高速集成电路探测器。输出探测器包含施密特触发器，为噪声免疫和脉冲整形提供了滞后效应。

The ATH11LX series of devices each consist of a GaAs infrared emitting diode optically coupled a high speed integrated circuit detector. The output detector incorporates a Schmitt trigger, which provides hysteresis for noise immunity and pulse shaping.

## 特性 Features

- 高数据速率，典型频率为 2MHz(NRZ)  
High data rate, 2MHz typical (NRZ)
- 在整个电压和温度范围内无门锁和振荡  
Free from latch up and oscillation throughout voltage and temperature ranges
- 兼容微处理器的驱动器  
Microprocessor compatible drive
- 输出在 0.4V 条件下的最大灌电流为：16mA  
Logic compatible output sinks 16mA at 0.4V maximum
- 保证导通/关断阈值滞后  
Guaranteed on/off threshold hysteresis
- 宽电源电压能力，兼容常见的逻辑电平  
Wide supply voltage capability, compatible with all popular logic systems
- 温度范围：-55°C ~ 100°C  
- 55°C to 100°C temperature range
- 紧凑型双列直插式封装  
Compact dual-in-line package
- 符合安规标准：UL 1577，VDE DIN EN60747-5-5 (VDE 0884-5)，CQC11-471543-2022  
Meet Safety standard：UL 1577, VDE DIN EN60747-5-5 (VDE 0884-5)，CQC11-471543-2022
- 无铅，符合 RoHS 标准  
Pb free and RoHS compliant.

## 应用 Applications

- 逻辑到逻辑隔离器  
Logic to logic isolator
- 可编程电流电平传感器  
Programmable current level sensor
- 线路接收机-消除噪声和瞬态问题  
Line receiver - eliminate noise and transient problems
- AC 到 TTL 的转换-方波整形  
AC to TTL conversion - square wave shaping

## 真值表 Truth table

LED	VO
H	L
L	H

## 封装和原理图 Package and Schematic Diagram

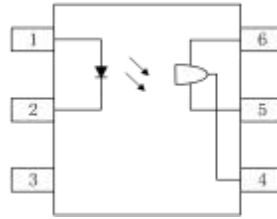

### Pin Configuration

- 1. Anode
- 2. Cathode
- 3. NC
- 4. VO
- 5. GND
- 6.VCC

## 产品型号命名规则 Order Code

# AT H11LX - UN Y - W (V) (ZZ)

- ①
- ②
- ③
- ④
- ⑤
- ⑥
- ⑦

- ① 公司代码 Company Code (AT: 奥特 Aote)
- ② 产品系列 Product Series (X: 1、2、3)
- ③ 框架类型 Lead Frame (Cu: 铜框架 Copper)
- ④ 树脂类型 Epoxy Type (H: 无卤 Halogen-free)
- ⑤ 封装形式 Package (S: SMD, D: DIP)
- ⑥ 器件工作温度范围 Device Operating Temperature Range (特殊范围需填或者空白 Special Range need to be filled in or left blank)
- ⑦ 内部补充代码 Internal Supplementary Code (数字或者空白 Number or None)

## 印字信息 Marking Information

- 印字中 “” 为奥特品牌 LOGO  
“” denotes LOGO
- 印字中的 “X” 代表产品分档：1、2、3  
“X” denotes the classification：1、2、3
- 印字中 “Y” 代表年份；A(2018),B(2019),C(2020) ... ..  
“Y” denotes YEAR：A(2018), B(2019), C(2020) ... ..
- 印字中 “WW” 代表周号  
“WW” denotes week’s number
- 印字中 “N” 代表星期几  
“N” denotes day of the week
- 印字中的 “H” 代表无卤  
“H” denotes Halogen-free



**绝缘和安规信息 Insulation and Safety related specifications**

项目 Item	符号 Symbol	数值 Value	单位 Unit	备注 Remark
爬电距离 Creepage Distance	L	≥7.6	mm	从输入端到输出端，沿本体最短距离路径 Measured from input terminals to output terminals, shortest distance path along body
电气间隙 Clearance Distance	L	≥7.6	mm	从输入端到输出端，通过空气的最短距离 Measured from input terminals to output terminals, shortest distance through air
绝缘距离 Insulation Thickness	DTI	≥0.4	mm	发射器和探测器之间的绝缘厚度 Insulation thickness between emitter and detector
峰值隔离电压 Peak Isolation Voltage	V <sub>IORM</sub>	1500	V <sub>peak</sub>	DIN/EN/IEC EN60747-5-5
瞬态隔离电压 Transient isolation voltage	V <sub>IOTM</sub>	7000	V <sub>peak</sub>	DIN/EN/IEC EN60747-5-5
隔离电压 Isolation Voltage	V <sub>iso</sub>	> 5000	V <sub>rms</sub>	For 1 min

**极限参数 Absolute Maximum Ratings (Ta = 25°C)**

参数 Parameter		符号 Symbol	额定值 Rating	单位 Unit
输入 Input	正向电流 Forward Current	I <sub>F</sub>	60	mA
	反向电压 Reverse Voltage	V <sub>R</sub>	6	V
	功耗 Power Dissipation	P <sub>D</sub>	120	mW
输出 Output	V45 允许范围 V45 Allowed Range	V <sub>O</sub>	0-16	V
	V65 允许范围 V65 Allowed Range	V <sub>CC</sub>	3-16	V
	输出电流 Output Current	I <sub>O</sub>	50	mA
	功耗 power dissipation	P <sub>D</sub>	150	mW
总功耗 Total Power Dissipation		P <sub>tot</sub>	250	mW
隔离电压 Isolation Voltage		V <sub>iso</sub>	5000	V <sub>rms</sub>
工作温度 Operating Temperature		T <sub>opr</sub>	-55 ~ +100	°C
储存温度 Storage Temperature		T <sub>stg</sub>	-55 ~ +125	°C
焊接温度 (10s) Soldering Temperature (10s)		T <sub>sol</sub>	260	°C

**产品特性参数 Electro-optical Characteristics (Ta = 25°C)**

参数 Parameter		符号 Symbol	条件 Condition	最小 Min.	典型 Typ.	最大 Max.	单位 Unit	
输入 Input	正向电压 Forward Voltage	$V_F$	$I_F=10\text{mA}$	-	1.24	1.5	V	
	反向电流 Reverse Current	$I_R$	$V_R=5\text{V}$	-	-	10	$\mu\text{A}$	
	输入电容 Input capacitance	$C_i$	$V=0, f=1\text{MHz}$	-	-	100	pF	
输出 Output	电压运行范围 Operation Voltage Range	$V_{CC}$		3	-	15	V	
	电源电流 Supply Current	$I_{CC(\text{off})}$	$I_F=0\text{mA}, V_{CC}=5\text{V}$		0.62	1.5	mA	
	高输出电流 Output Current, High	$I_{OH}$	$I_F=0\text{mA}, V_{CC}=V_O=15\text{V}$	-	-	100	$\mu\text{A}$	
	隔离电阻 Isolation Resistance	$R_{ISO}$	$V_{I-O}=500\text{VDC}$	$10^{11}$	-	-	$\Omega$	
传输特性 Transfer Characteristics	电源电流 Supply Current	$I_{CC(\text{on})}$	$I_F=10\text{mA}, V_{CC}=5\text{V}$	-	0.67	1.5	mA	
	低输出电压 Output Voltage .low	$V_{OL}$	$V_{CC}=5\text{V}, I_F=I_{Fon(\text{max})}$ $R_L=270\Omega$	-	-	0.4	V	
	开启阈值电流 Turn onThreshold Current	ATH11L1	$I_{Fon}$	$V_{CC}=5\text{V}, R_L=270\Omega$	-	-	1.6	mA
		ATH11L2			-	-	10	
		ATH11L3			-	-	5	
	滞后比 Hysteresis Ratio	$I_{Foff}/I_{Fon}$	$V_{CC}=5\text{V}, R_L=270\Omega$	0.5	-	0.9		
	开启时间 Turn on Time	$t_{on}$	$V_{CC}=5\text{V}, I_F=I_{Fon},$ $R_L=270\Omega$	-	-	4	$\mu\text{s}$	
	下降时间 Fall Time	$t_f$		-	0.1	-	$\mu\text{s}$	
关闭时间 Turn off Time	$t_{off}$	-		-	4	$\mu\text{s}$		
上升时间 Rise Time	$t_r$	-		0.1	-	$\mu\text{s}$		
数据速率 Data Rate			-	2	-	MHz		

**典型光电特性曲线 Typical Electro-Optical Characteristics Curves**

Fig.1 Forward current vs Forward Voltage

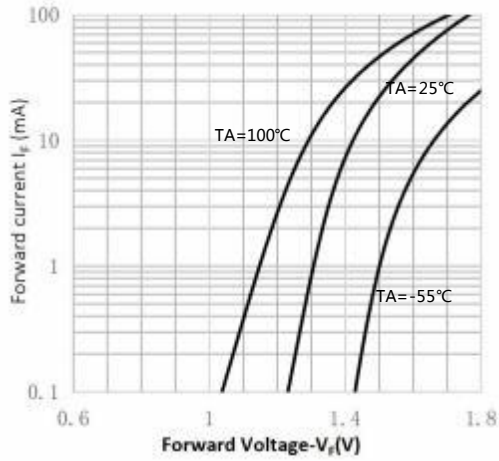

Fig.2 Transfer characteristic

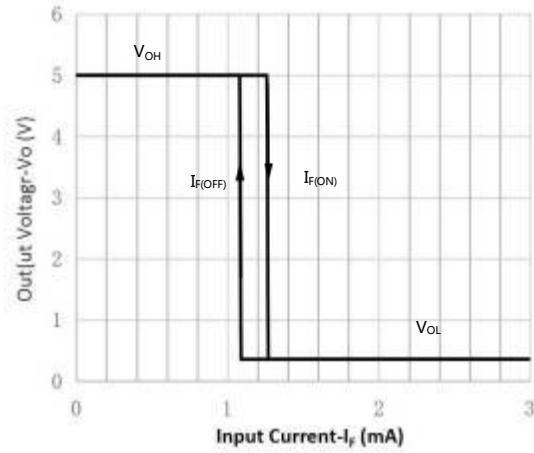

Fig.3 Turn On Threshold Current vs Supply Voltage

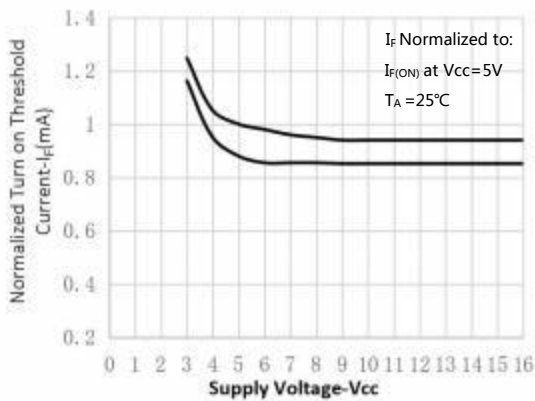

Fig.4 Turn On Threshold Current vs Ambient temperature

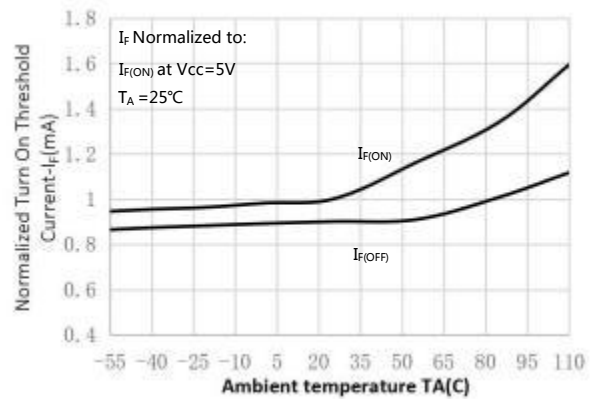

Fig.5 Low Level Output Voltage vs Load Current

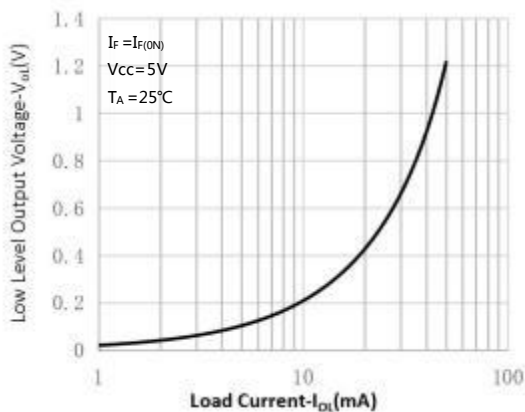
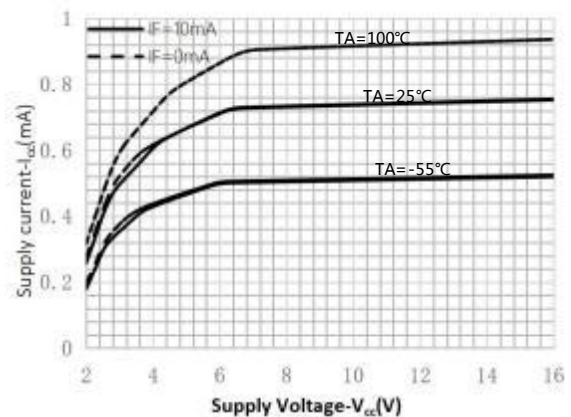
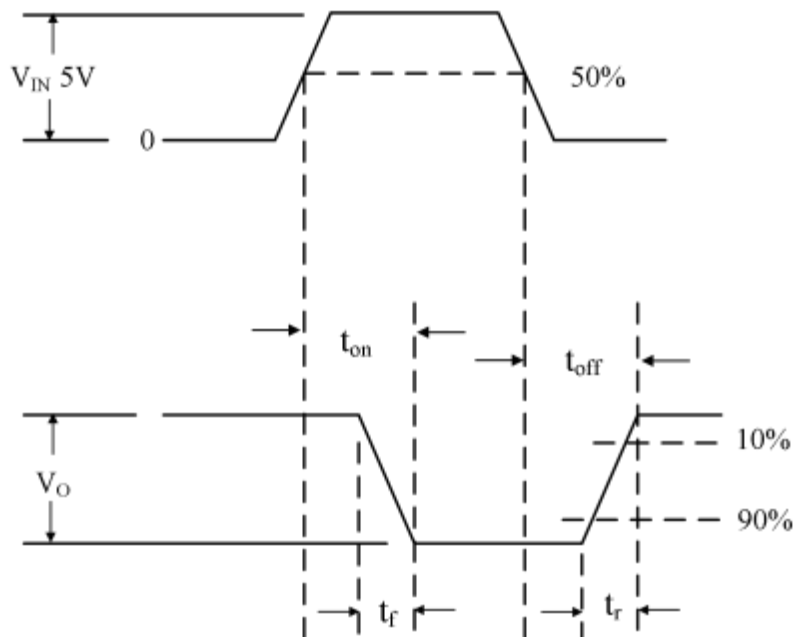
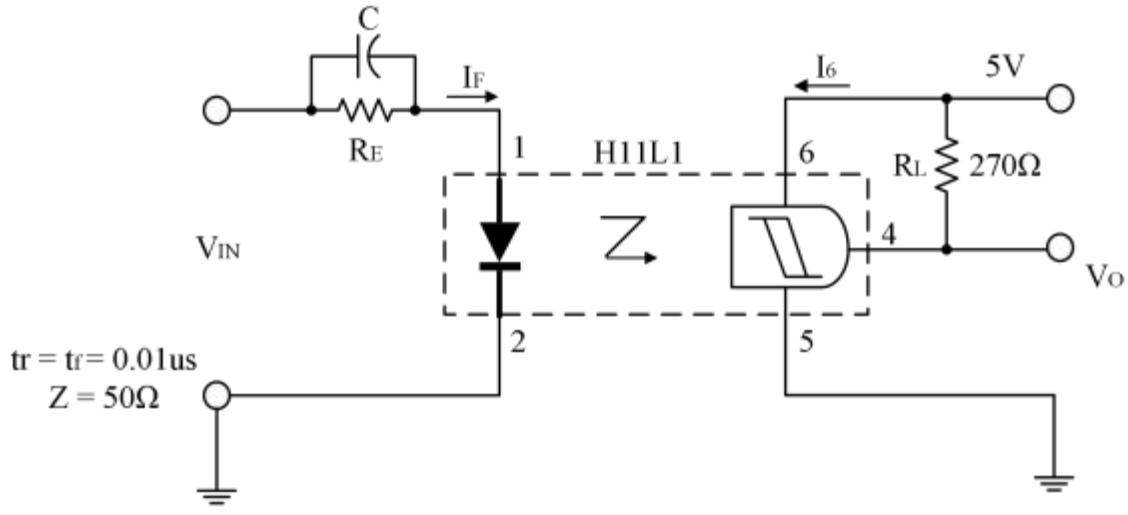

Fig.6 Supply current vs Supply Voltage



**开关时间测试电路 Switching Time Test Circuit & Waveforms**



**外形尺寸 Outline Dimensions**

**DIP6**

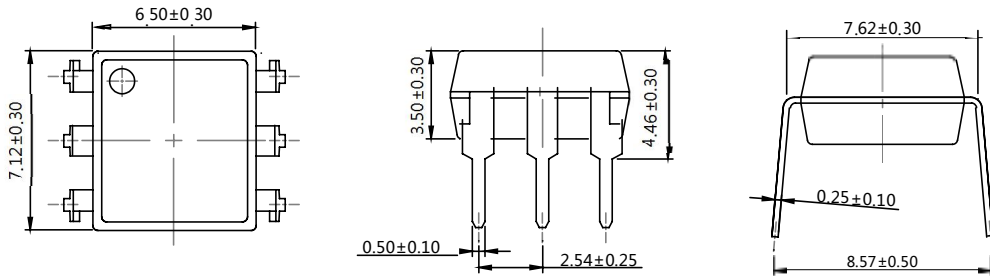

**SMD6**

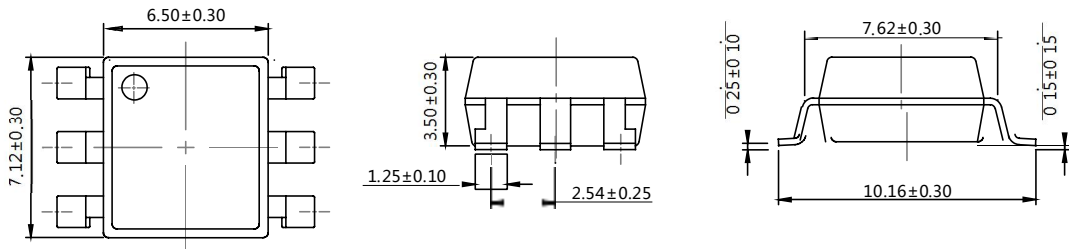

单位 Unit: mm

**建议焊盘布局 Recommended Pad Layout**

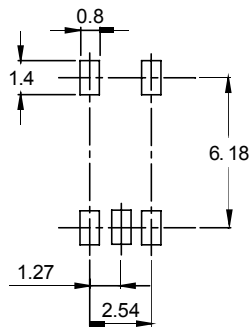

单位 Unit: mm

注：上图为产品正视图。

Note: The picture above is the front view of the product.



**回流焊温度曲线图 Solder Reflow Profile**

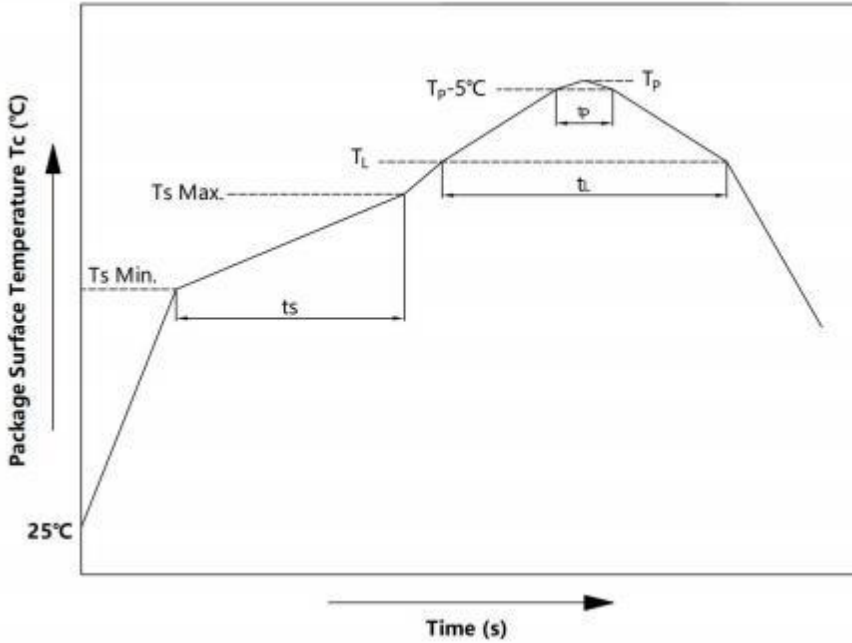

项目 Item	符号 Symbol	最小值 Min.	最大值 Max.	单位 Unit
预热温度 Preheat Temperature	$T_s$	150	200	$^\circ\text{C}$
预热时间 Preheat Time	$t_s$	60	120	s
升温速率 Ramp-Up Rate ( $T_L$ to $T_P$ )	-	-	3	$^\circ\text{C}/\text{s}$
液相线温度 Liquidus Temperature	$T_L$	217		$^\circ\text{C}$
时间高于 $T_L$ Time Above $T_L$	$t_l$	60	150	s
峰值温度 Peak Temperature	$T_P$	-	260	$^\circ\text{C}$
$T_c$ 在 $(T_P - 5)$ 和 $T_P$ 之间的时间 Time During Which $T_c$ Is Between $(T_P - 5)$ and $T_P$	$t_p$	-	30	s
降温速率 Ramp-down Rate ( $T_P$ to $T_L$ )	-	-	6	$^\circ\text{C}/\text{s}$

注 Note :

建议在所示的温度和时间条件下进行回流焊，最多不能超过三次；

Reflow soldering is recommended at the temperatures and times shown, no more than three times;

### 波峰焊温度曲线图 Wave Soldering Profile

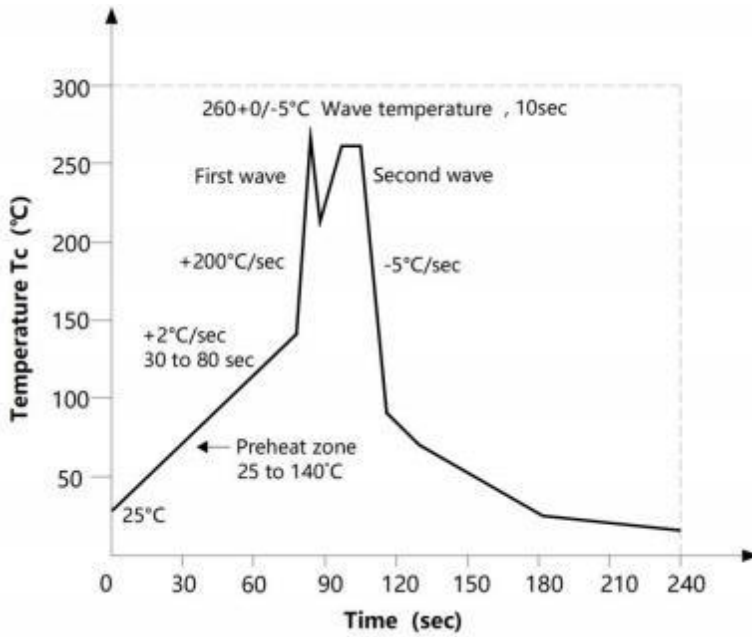

### 手工烙铁焊接 Soldering with hand soldering iron

- A. 手工烙铁焊仅用于产品返修或样品测试；  
Hand soldering iron is only used for product rework or sample testing;
- B. 手工烙铁焊要求：温度  $360^{\circ}\text{C} \pm 5^{\circ}\text{C}$ ，时间  $\leq 3\text{s}$ 。  
Hand soldering iron requirements：Temperature： $360^{\circ}\text{C} \pm 5^{\circ}\text{C}$ , within 3s.

## 包装 Packing

### ■ 汇总表 Summary table

封装形式	包装方式	盘数量	盒数量	箱数量	静电袋规格	盒规格	箱(双瓦楞)规格	备注
DIP6	管装 (500*12*11mm)	65 只/管	50 管/盒	10 盒/箱	不适用	525*128*56mm	535*275*300mm	每管使用蓝白胶塞, 方向须一致
SMD6	卷盘 (φ330mm 蓝盘)	1 千只/盘	2 盘/盒	10 盒/箱	450*390*0.1mm	340*60*340mm	620*360*365mm	首尾端至少空 200 毫米
Package Type	Packing Form	Quantity per Reel	Quantity per Box	Quantity per Carton	Antistatic Bag Specification	Box Specification	Carton Specification	Note
DIP6	Tube (500*12*11mm)	65 pcs/tube	50 tubes/box	10 boxes/ctn	Not applicable	525*128*56mm	535*275*300mm	Use blue and white rubber stoppers for each tube, with the same direction
SMD6	Reel (φ330mm Blue)	1k pcs/reel	2 reels/box	10 boxes /ctn	450*390*0.1mm	340*60*340mm	620*360*365mm	Guard band 200mm min.

### ■ 条管包装 Tube

- 1) 每箱数量：32500 只。  
Qty/ctn：22500pcs
- 2) 内包装：Inner packing：
  - i. 每条管 65 只。  
65pcs/tube
  - ii. 每盒 50 条管。  
50 tubes/box
- 3) 示意图 Schematic：

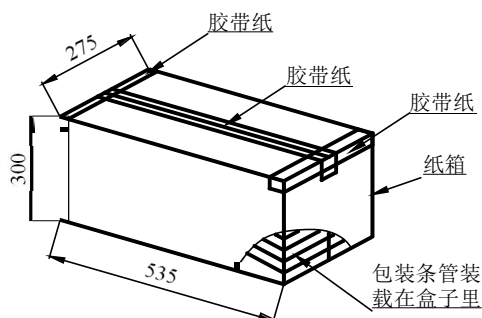

### ■ 编带包装 Tape & Reel

- 1) 每卷数量：1000 只。  
Qty/reel：1000 pcs.
- 2) 每箱数量：20000 只。  
Qty/ctn：20000 pcs.
- 3) 内包装：每盒 2 盘。  
Inner packing：2 reels/box.
- 4) 示意图 Schematic：

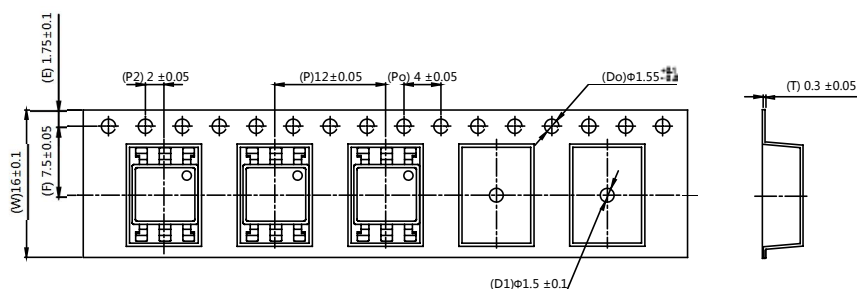

单位 Unit：mm

## 注意 Attention

- 奥特持续不断改进质量、可靠性、功能或设计，保留此文件更改的权利恕不另行通知。  
AOTE continuously improve quality, reliability, function and design. We reserve the right to change this document without prior notice.
- 请遵守产品规格书使用，奥特不对使用时不符合产品规格书条件而导致的质量问题负责。  
Please use in accordance with the product specification. AOTE is not responsible for the quality problems caused by non-compliance with the product specifications.
- 对于需要高可靠性或安全性的设备/装置需求，请联系我们的销售人员。  
For equipment/devices requiring high reliability or safety, please contact our sales representatives.
- 当需要用于任何“特定”应用时，请咨询我们的销售人员。  
When requiring a device for any “specific” application, please contact our sales in advice.
- 如对文件中表述的内容有疑问，欢迎联系我们。  
If you have any questions about the contents of the document, please contact us.