



光继电器
Photo Relay

AT213
AT223

Product Data Sheet

AOTE DCC
RELEASE

台湾奥特半导体科技有限公司

TAIWAN AOTE SEMICONDUCTOR TECHNOLOGY CO.,LTD

www.aotesemi.com

概述 Description

AT213/AT223 光继电器由红外发光二极管和光电发生器、 MOSFET 组成。

The AT213/AT223 Photo relay consist of a photo MOSFET、 Photovoltage generator、 infrared LED.

特性 Features

- 常开,单刀单掷
Normally opened (SPST)
- 控制 100V 交流或直流电压
Control 100V AC or DC voltage
- 开关 1.25A 负载
Switch 1.25A load
- 控制低电平模拟信号
Controls low-level analog signal
- 高灵敏度, 低导通电阻
High sensitivity, low conductivity resistance
- 低电平关断漏电流
Low-level off state leakage current
- 高隔离电压 $5000V_{rms}$
High isolation voltage $5000V_{rms}$
- 无铅, 符合 RoHS 标准
Lead free, meet RoHS standards

应用 Applications

- 通讯产品(个人电脑,笔记本电脑)
Communications products (Personal computers, Laptops)
- 调制解调器/传感器
Modem/Sensor
- 移动电话 /安全设备
Mobile phones/Security equipment
- 测量和测试设备
Measuring and Testing equipment
- 工厂自动化设备
Plant automation equipment
- 高速检验机器
High-speed inspection machines

封装和原理图 Package and Schematic Diagram

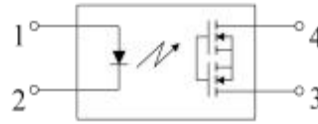

Pin Configuration

- 1. Anode
- 2. Cathode
- 3.4. Drain

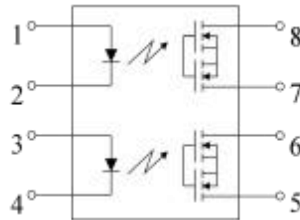

Pin Configuration

- 1.3. Anode
- 2.4. Cathode
- 5.6.7.8 Drain

产品型号命名规则 Order Code

AT 2A3 - UN Y - W (V) (ZZ)

① ② ③ ④ ⑤ ⑥ ⑦

- ① 公司代码 Company Code (AT: 奥特 Aote)
- ② 产品系列 Product Series (212: 213; 223: 223)
- ③ 框架类型 Lead Frame (Cu: 铜框架 Copper)
- ④ 树脂类型 Epoxy Type (H: 无卤 Halogen-free, L: 有卤/无铅 Halogen/Lead-free)
- ⑤ 封装形式 Package (D: DIP; S: SMD;)
- ⑥ 器件工作温度范围 Device Operating Temperature Range (特殊范围需填或者空白 Special Range need to be filled in or left blank)
- ⑦ 内部补充代码 Internal Supplementary Code (数字或者空白 Number or None)

印字信息 Marking Information

- 印字中 “” 为奥特品牌 LOGO
“” denotes LOGO
- 印字中 “Y” 代表年份：A(2018),B(2019),C(2020)
“Y” denotes YEAR：A(2018), B(2019), C(2020)
- 印字中 “WW” 代表周号
“WW” denotes Week’ s number
- 印字中 “N” 代表星期几
“N” denotes the day of the week
- 印字中的 “H” 代表无卤，而当产品有卤/无铅时，此处空白
“H” denotes Halogen-free, when the product has halogen/lead-free, leave this blank.

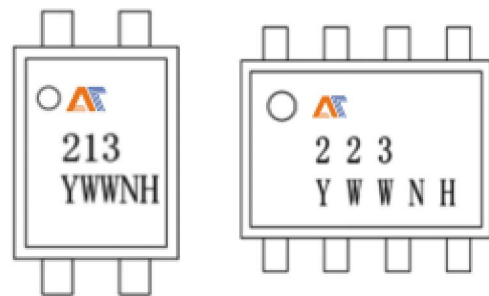

绝缘和安规信息 Insulation and Safety related specifications

项目 Item	符号 Symbol	数值 Value	单位 Unit	备注 Note
爬电距离 Creepage Distance	L	7.0	mm	从输入端到输出端，沿本体最短距离路径 Measured from input terminals to output terminals, shortest distance path along body.
电气间隙 Clearance Distance	L	7.0	mm	从输入端到输出端，通过空气的最短距离 Measured from input terminals to output terminals, shortest distance through air.
绝缘距离 Insulation Thickness	DTI	0.4	mm	发射器和探测器之间的绝缘厚度 Insulation thickness between emitter and detector.
峰值隔离电压 Peak Isolation Voltage	V_{IORM}	1500	V_{peak}	DIN/EN/IEC EN60747-5-5
瞬态隔离电压 Transient Isolation Voltage	V_{IOTM}	7000	V_{peak}	DIN/EN/IEC EN60747-5-5
隔离电压 Isolation Voltage	V_{ISO}	5000	V_{rms}	RH ≤ 50%, $t_m = 1$ minute, $T_A = 25^\circ\text{C}$.

极限参数 Absolute Maximum Ratings ($T_A = 25^\circ\text{C}$)

参数 Parameter	符号 Symbol	最小 Min.	最大 Max.	单位 Unit	备注 Note	
发射端 Input	LED 正向电流 LED Forward Current	I_F	-	50	mA	
	LED 反向电压 LED Reverse Voltage	V_R	-	6	V	
	峰值正向电流 Peak Forward Current	I_{FP}	-	1	A	f = 100 Hz, duty cycle = 0.1%
	输入功率 Power Dissipation	P_{in}	-	75	mW	
接收端 Output	持续负载电流 Continuous Load Current	I_L	-	1.25	A	
	峰值负载电流 Peak Load Current	I_{peak}	-	3.7	A	$t_m = 1$ min, duty cycle = 0.1%, cumulative of 5minutes over lifetime
	输出功率 Power Dissipation	P_{out}	AT213	500	mW	
	AT223		-	800		
总功耗 Total Power Dissipation	P_{tot}	AT213	-	550	mW	
		AT223	-	850		
输入输出瞬态耐受电压 Isolation Voltage	V_{ISO}	5000	-	V_{rms}	RH ≤ 50% $t_m = 1$ minute	
工作温度 Operating Temperature	T_{opr}	-40	+85	$^\circ\text{C}$		
存储温度 Storage Temperature	T_{stg}	-40	+100	$^\circ\text{C}$		

产品特性参数 Electro-optical Characteristics ($T_A = 25^\circ\text{C}$)

参数 Parameter		符号 Symbol	条件 Condition	最小 Min.	典型 Typ.	最大 Max.	单位 Unit
发射端 Input	LED 开启电流 LED Operate Current	I_{Fon}	$I_L = \text{Max.}$	-	0.5	3	mA
	LED 关断电流 LED Turn Off Current	I_{Foff}	$I_L = \text{Max}$	0.2	0.4	-	mA
	反向电流 Reverse Current	I_R	$V_R = 5V$	-	-	10	μA
	LED 正向压降 LED Dropout Voltage	V_F	$I_F = 5\text{mA}$	1	1.3	1.4	V
接收端 Output	负载电压 (AC 峰值) Load Voltage (Peak AC)	V_L	$I_{\text{OFF}} = 10\mu\text{A}$	100	110	-	V
	导通电阻 On Resistance	R_{on}	$I_F = 5\text{mA}; I_L = \text{Max.}$ Within 1s on time	-	0.3	1.5	Ω
	关断漏电 Off State Leakage Current	I_{Leak}	$I_F = 0\text{mA}; V_L = 100V$	-	-	10	μA
传输特性 Transfer Characteristics	开启时间 Turn On Time	T_{on}	$I_F = 5\text{mA}; I_L = 100\text{mA}$ $V_L = 20V, R_L = 200\Omega$	-	0.25	1	ms
	关断时间 Turn Off Time	T_{off}		-	0.3	1	ms
	I/O 电容 I/O Capacitance	C_{ISO}	$F = 1\text{MHz}; V_B = 0V$	-	0.8	1.5	pF
	初始 I/O 隔离电阻 Initial I/O Isolation Resistance	R_{ISO}	500VDC	10^9	-	-	Ω

典型光电特性曲线 Typical Electro-Optical Characteristics Curves

Fig.1 On Resistance vs. Ambient Temperature Characteristics (DC)

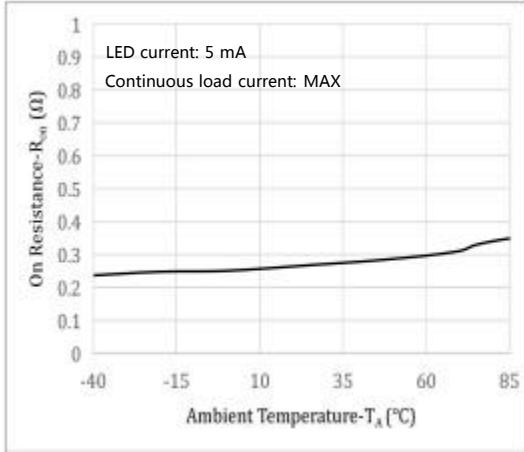

Fig.2 Current vs. Voltage Characteristics Of Output At MOS Portion

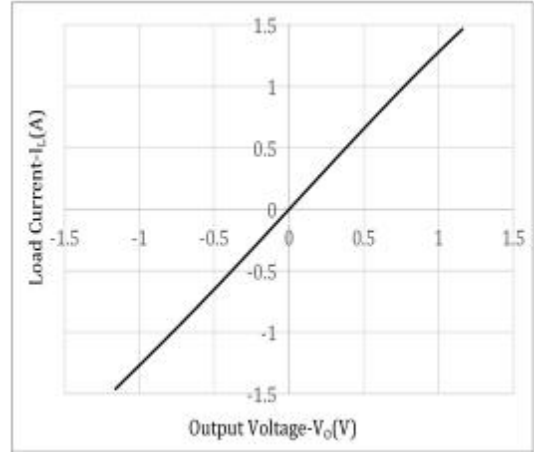

Fig.4 LED Turn On Current vs. Ambient Temperature Characteristics

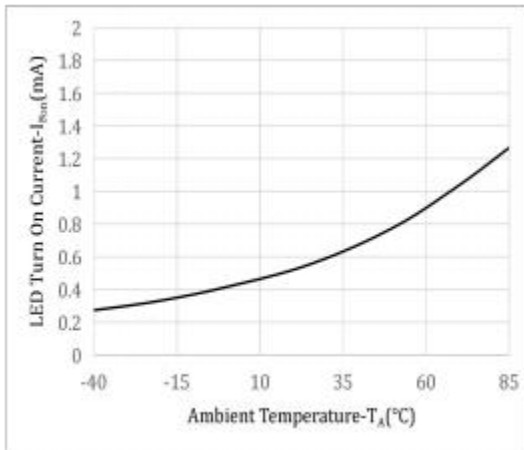

Fig.4 LED Turn Off Current vs. Ambient Temperature Characteristics

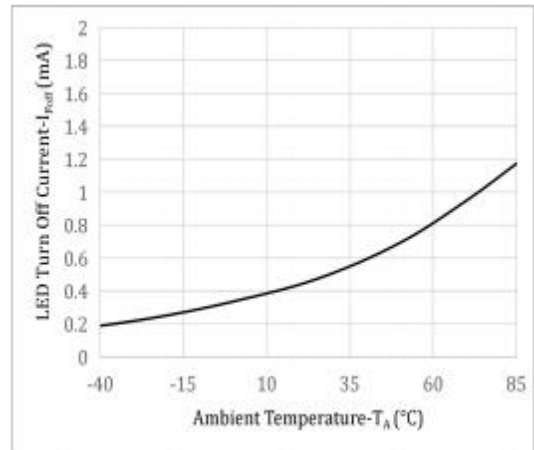

Fig.5 Turn On Time vs. Ambient Temperature Characteristics

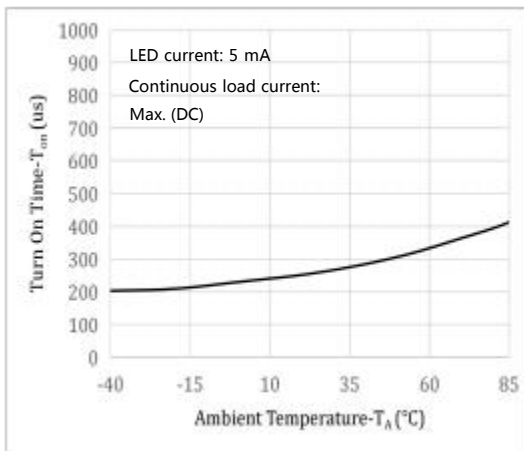

Fig.6 Turn Off Time vs. Ambient Temperature Characteristics

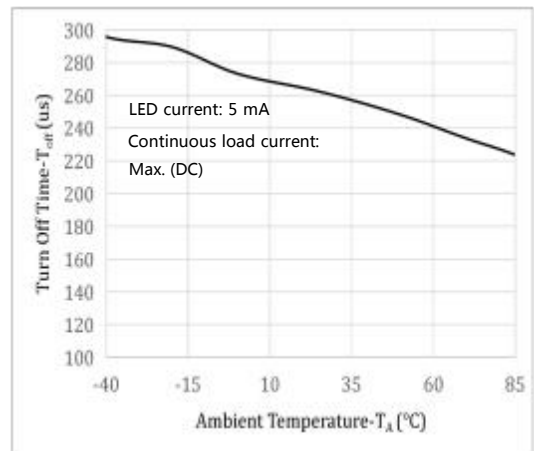

Fig.7 Turn On Time vs. LED Forward Current Characteristics

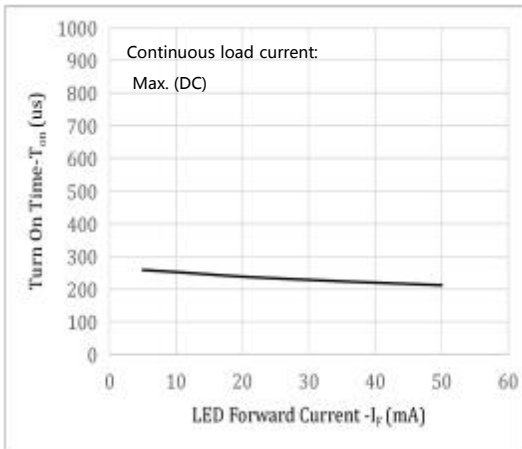

Fig.8 Turn Off Time vs. LED Forward Current Characteristics

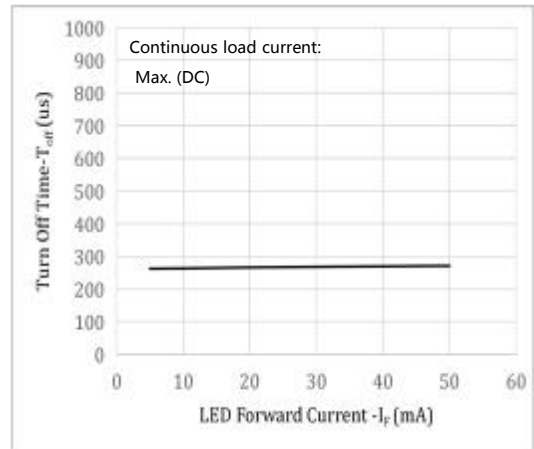

Fig.9 LED Forward Current VS LED Forward Voltage

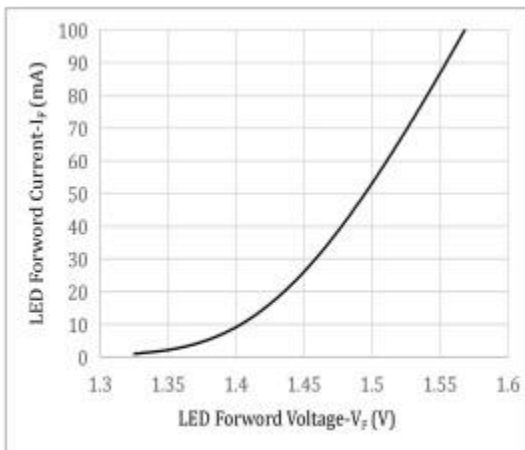

Fig.10 LED Dropout Voltage vs. Ambient Temperature Characteristics

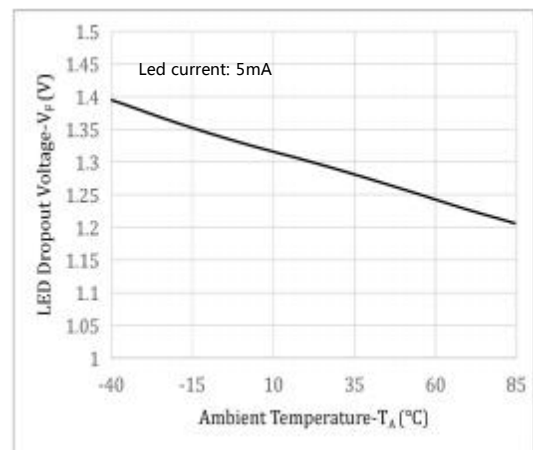

Fig.11 Output Leakage Current vs Ambient Temperature

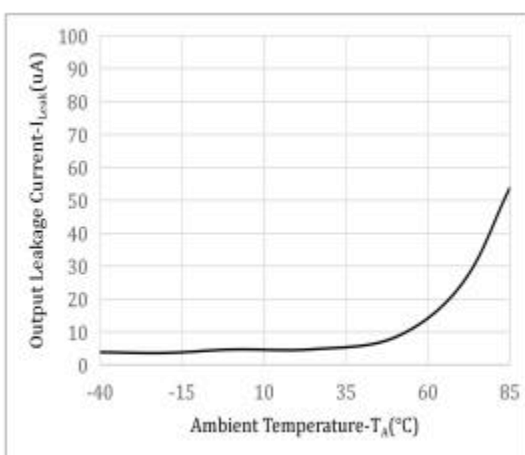
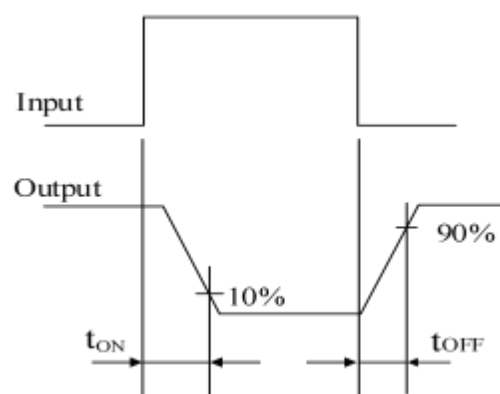
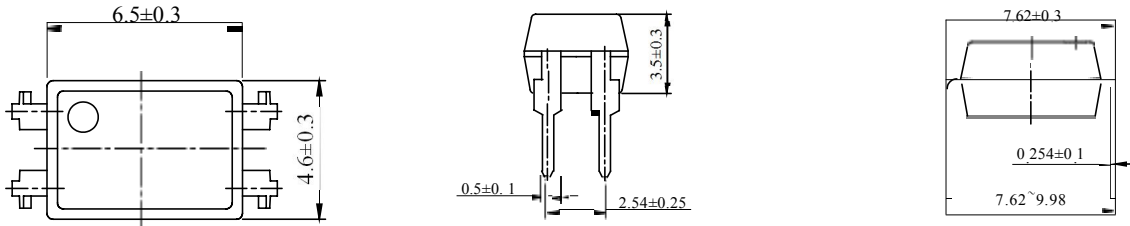

Fig.12 Turn on/off time



外形尺寸 Outline Dimensions

DIP4



单位 Unit: mm

SMD4

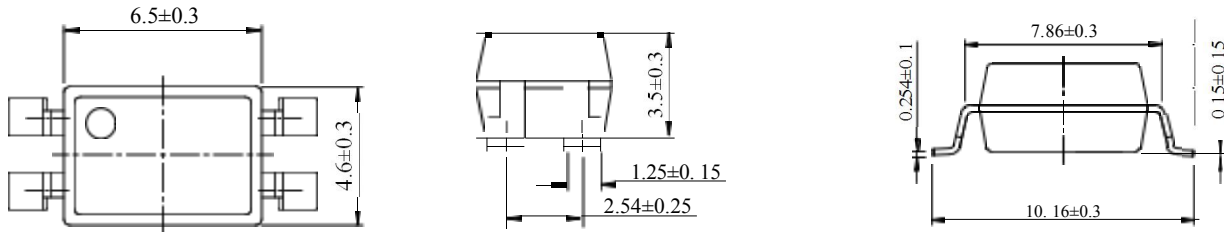

单位 Unit: mm

DIP8

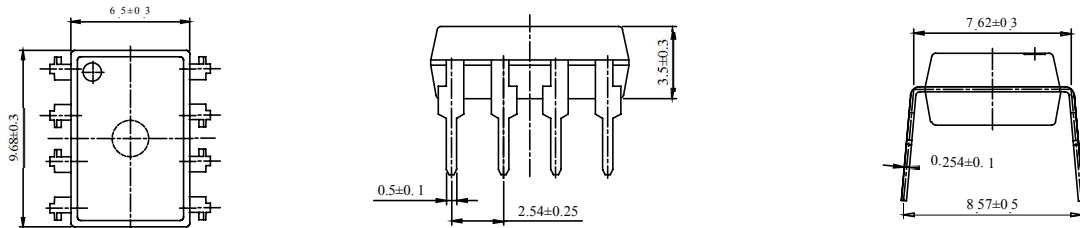

单位 Unit: mm

SMD8

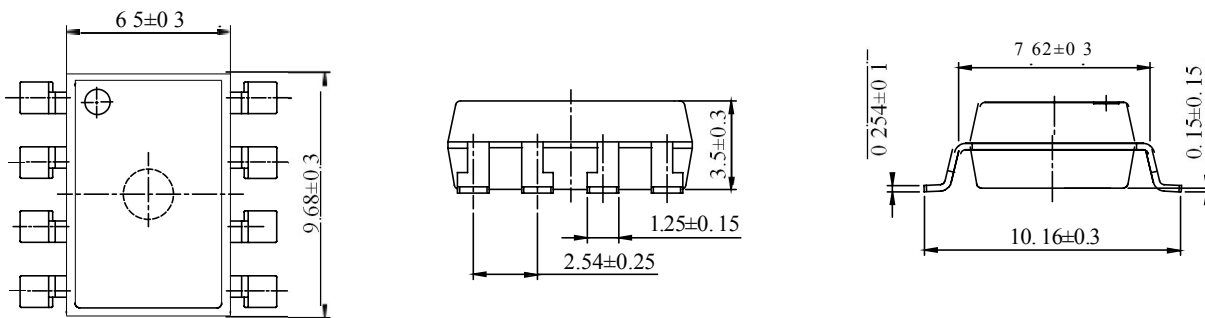

单位 Unit: mm

建议焊盘布局 Recommended Pad Layout

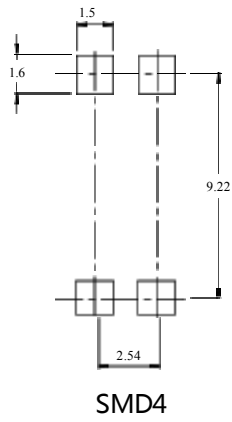

SMD4

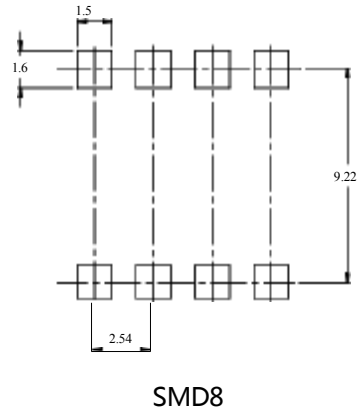

SMD8

单位 Unit: mm

注：上图为产品正视图。

Note : The picture above is the front view of the product.

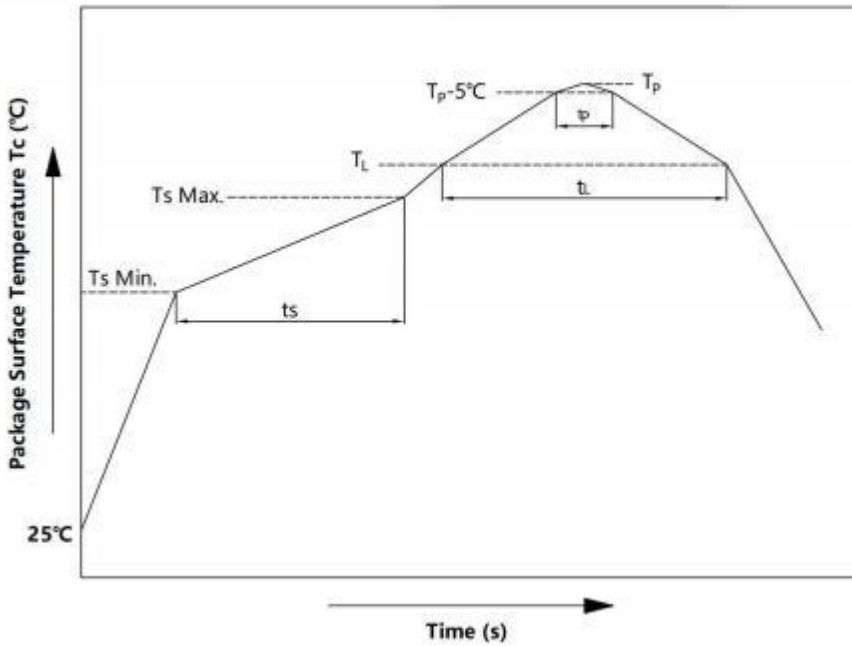
回流焊温度曲线图 Solder Reflow Profile

项目 Item	符号 Symbol	最小值 Min.	最大值 Max.	单位 Unit
预热温度 Preheat Temperature	T_s	150	200	°C
预热时间 Preheat Time	t_s	60	120	s
升温速率 Ramp-Up Rate (T_L to T_P)	-	-	3	°C/s
液相线温度 Liquidus Temperature	T_L	217		°C
时间高于 T_L Time Above T_L	t_L	60	150	s
峰值温度 Peak Temperature	T_P	-	260	°C
T_c 在 ($T_P - 5$) 和 T_P 之间的时间 Time During Which T_c Is Between ($T_P - 5$) and T_P	t_p	-	30	s
降温速率 Ramp-down Rate (T_P to T_L)	-	-	6	°C/s

注：建议在所示的温度和时间条件下进行回流焊，最多不能超过三次。

Note: Reflow soldering is recommended at the temperatures and times shown, no more than three times.

波峰焊温度曲线图 Wave Soldering Profile

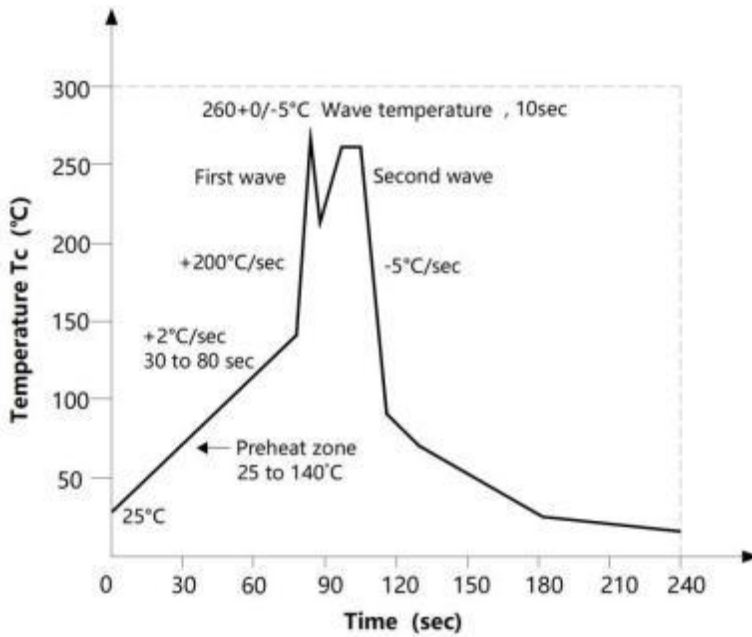

手工烙铁焊接 Soldering with hand soldering iron

- A. 手工烙铁焊仅用于产品返修或样品测试；
Hand soldering iron is only used for product rework or sample testing;
- B. 手工烙铁焊要求：温度 $360^{\circ}\text{C} \pm 5^{\circ}\text{C}$ ，时间 $\leq 3\text{s}$ 。
Manual soldering method Temperature: $360^{\circ}\text{C} \pm 5^{\circ}\text{C}$, within 3s.

包装 Packing

■ 汇总表 Summary table

封装形式	包装方式	盘数量	盒数量	箱数量	静电袋规格	盒规格	箱(双瓦楞)规格	备注
DIP4	管装 (500*12*11mm)	100 只/管	50 管/盒	10 盒/箱	不适用	52.5*12.8*5.6cm	53.5*27.5*30cm	每管使用蓝白胶塞，方向须一致
DIP8	管装 (500*12*11mm)	45 只/管	50 管/盒	10 盒/箱	不适用	52.5*12.8*5.6cm	53.5*27.5*30cm	
SMD4	卷盘 (φ330mm 蓝盘)	2000 只/盘	2 盘/盒	10 盒/箱	380*380mm	34*6*34cm	62*36*36.5cm	首尾端空至少 200mm
SMD8	卷盘 (φ330mm 蓝盘)	1000 只/盘	2 盘/盒	10 盒/箱	380*380mm	34*6*34cm	62*36*36.5cm	
Package Type	Packing Form	Quantity per Reel	Quantity per Box	Quantity per Carton	Antistatic Bag Specification	Box Specification	Carton Specification	Note
DIP4	Tube (500*12*11mm)	100pcs /tube	50 tubes/box	10 boxes /ctn	NA	52.5*12.8*5.6cm	53.5*27.5*30cm	Use blue and white rubber stoppers for each tube, with the same direction
DIP8	Tube (500*12*11mm)	45pcs /tube	50 tubes/box	10 boxes /ctn	NA	52.5*12.8*5.6cm	53.5*27.5*30cm	
SMD4	Reel (φ330mm Blue)	2000 pcs /reel	2 reels /box	10 boxes /ctn	380*380mm	34*6*34cm	62*36*36.5cm	Leave at least 200mm of blank space at both ends
SMD8	Reel (φ330mm Blue)	1000 pcs /reel	2 reels /box	10 boxes /ctn	380*380mm	34*6*34cm	62*36*36.5cm	

■ DIP4 条管包装 Tube

- 1) 每管数量：100 只。
Qty/reel：100 pcs.
- 2) 每箱数量：50000 只。
Qty/ctn：50000 pcs.
- 3) 内包装：每盒 50 管。
Inner packing：50 tubes/box.

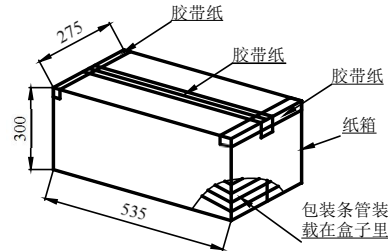

■ DIP8 条管包装 Tube

- 4) 每管数量：45 只。
Qty/reel：45 pcs.
- 5) 每箱数量：22500 只。
Qty/ctn：22500 pcs.
- 6) 内包装：每盒 50 管。
Inner packing：50 tubes/box.

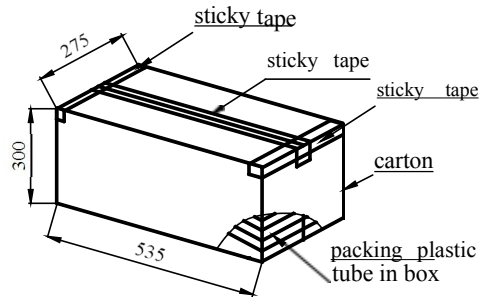

■ SMD4 编带包装 Tape & Reel

- 7) 每卷数量：2000 只。
Qty/reel：2000 pcs.
- 8) 每箱数量：40000 只。
Qty/ctn：40000 pcs.
- 9) 内包装：每盒 2 盘。
Inner packing：2 reels/box.
- 10) 示意图 Schematic：

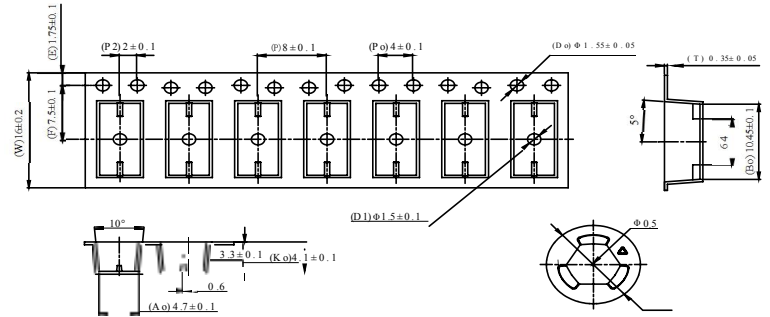

单位 Unit：mm

■ SMD8 编带包装 Tape & Reel

- 11) 每卷数量：1000 只。
Qty/reel：1000 pcs.
- 12) 每箱数量：20000 只。
Qty/ctn：20000 pcs.
- 13) 内包装：每盒 2 盘。
Inner packing：2 reels/box.

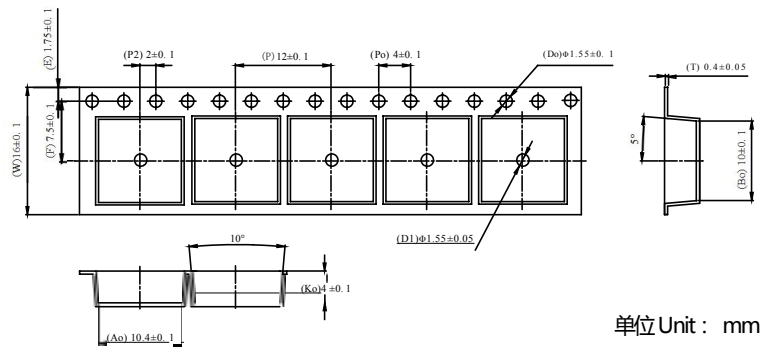

单位 Unit：mm

注意 Attention

- 奥特持续不断改进质量、可靠性、功能或设计，保留此文件更改的权利恕不另行通知。
AOTE continuously improve quality, reliability, function or design. We reserve the right to change this document without notice.
- 请遵守产品规格书使用，奥特不对使用时不符合产品规格书条件而导致的质量问题负责。
Please use in accordance with the product specification. AOTE is not responsible for the quality problems caused by non-compliance with the product specifications.
- 对于需要高可靠性或安全性的设备/装置需求，请联系我们的销售人员。
For equipment/devices where high reliability or safety is required, please contact our sales representatives.
- 当需要用于任何“特定”应用时，请咨询我们的销售人员。
When requiring a device for any “specific” application, please contact our sales in advice.
- 如对文件中表述的内容有疑问，欢迎联系我们。
If you have any questions about the contents of the document, please contact us.